

observation
sketch

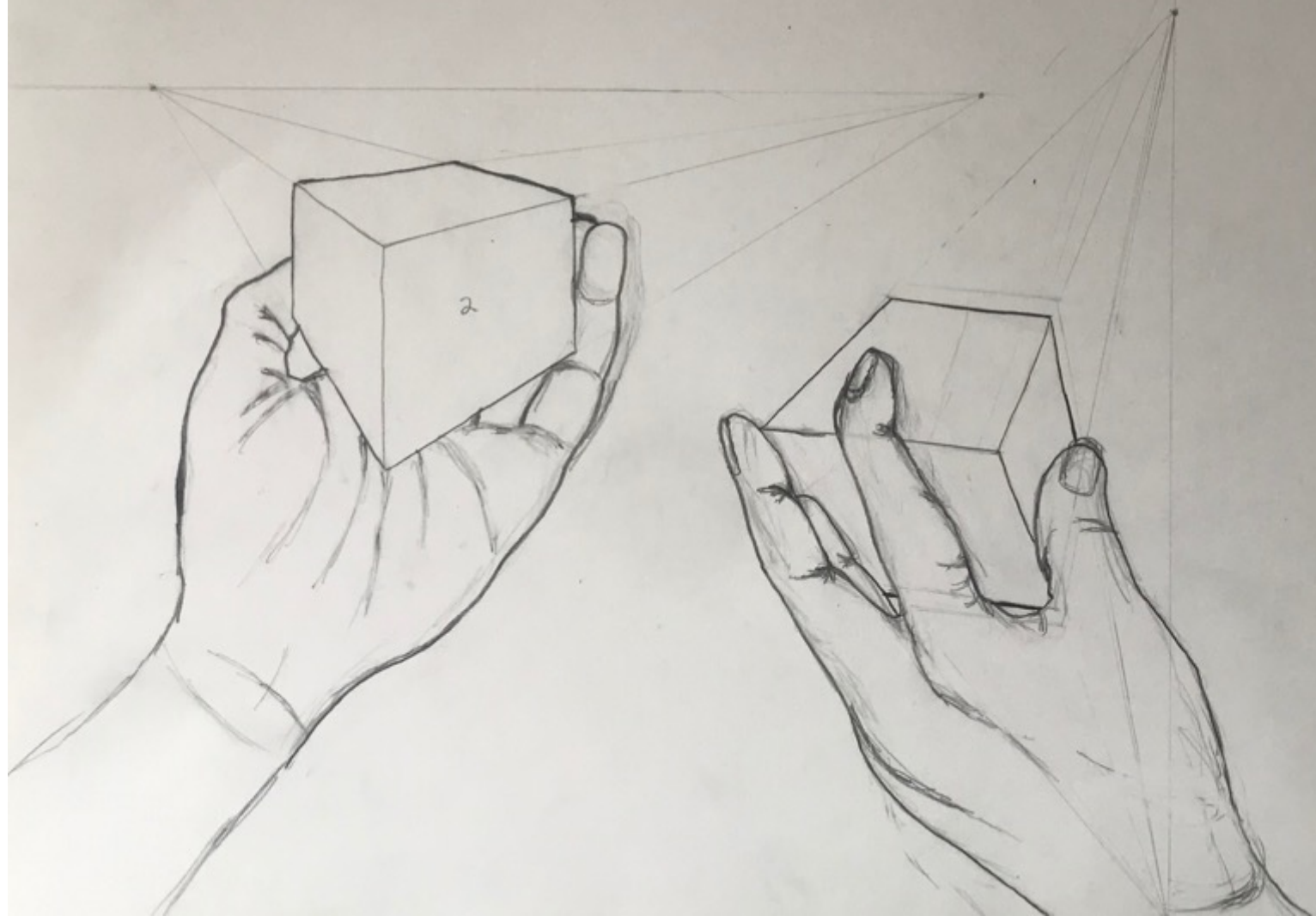

Rough sketch

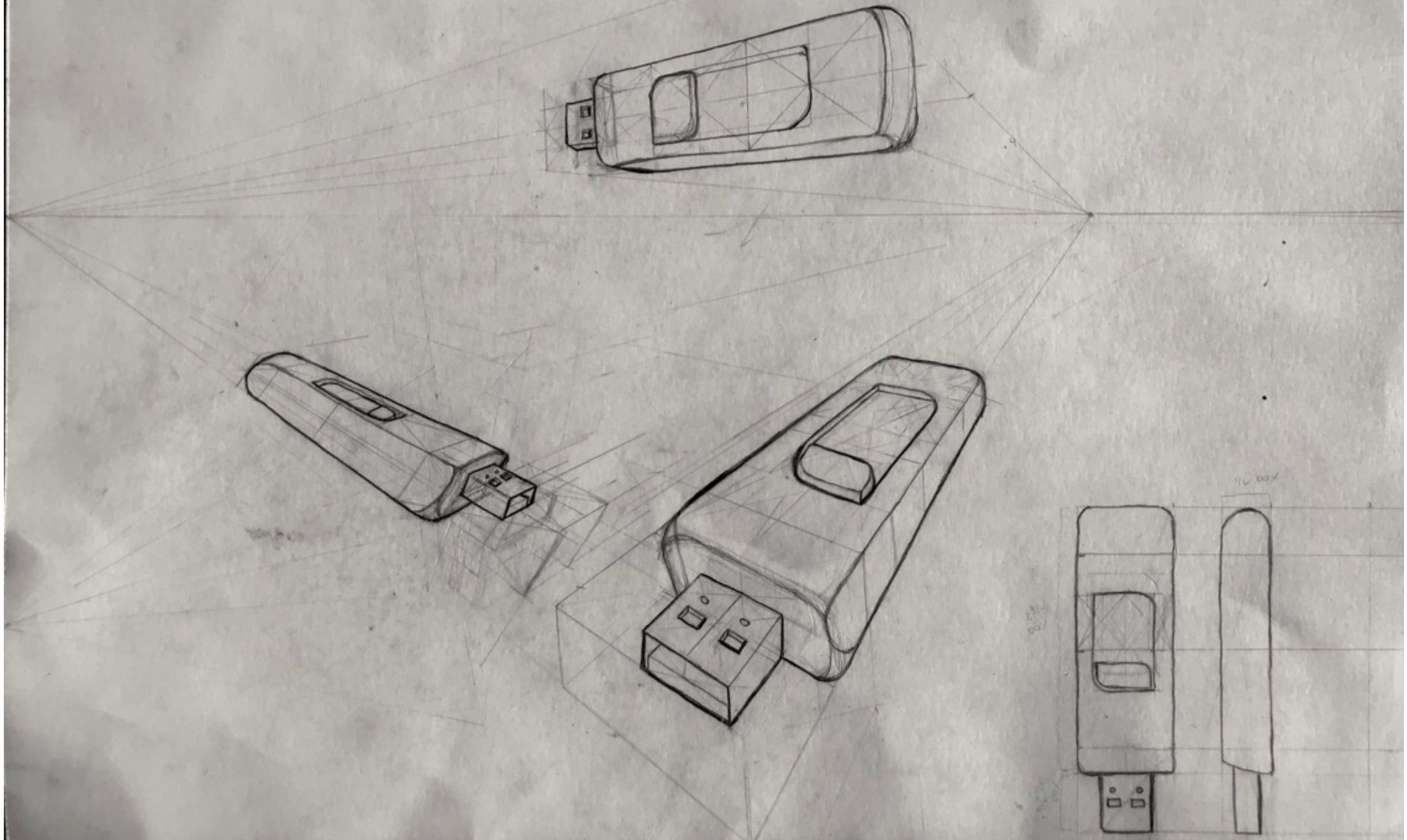

Rough sketch

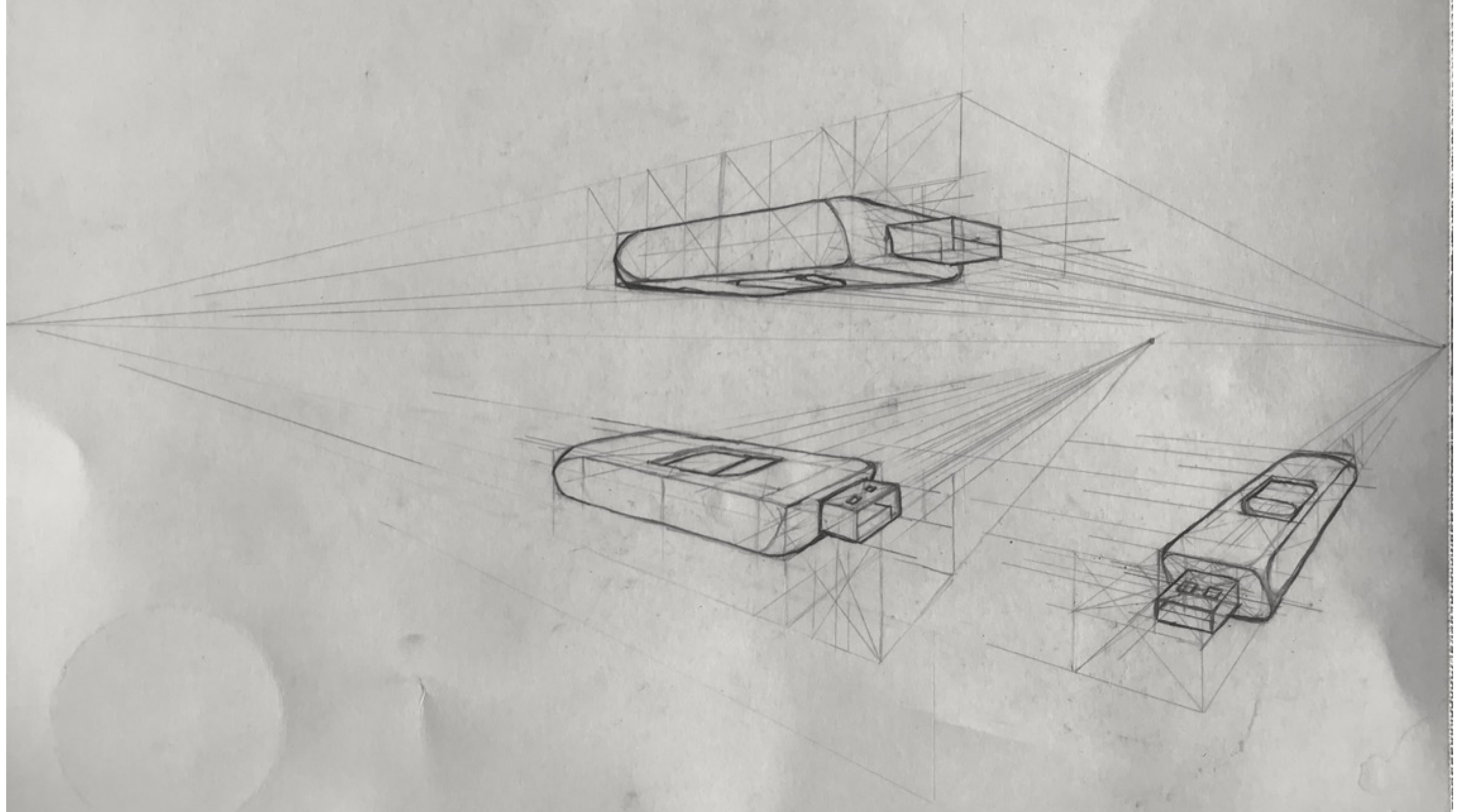

Final

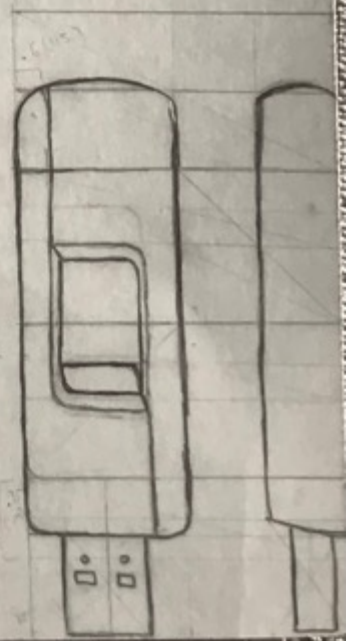
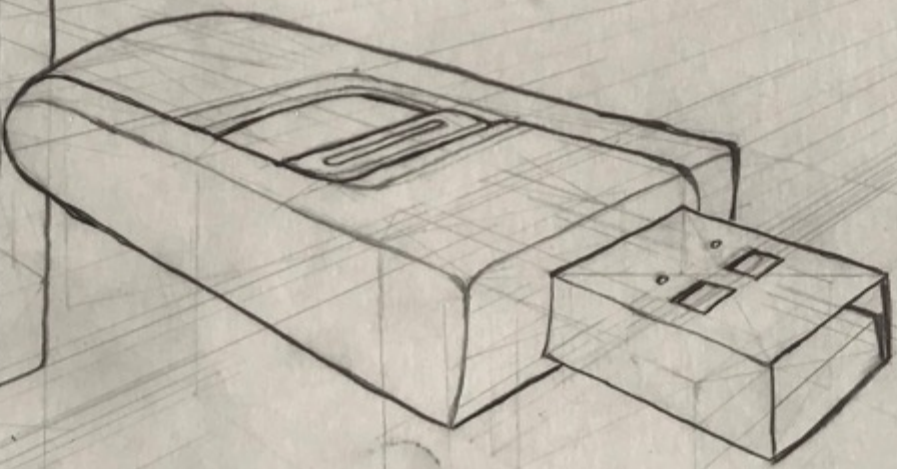
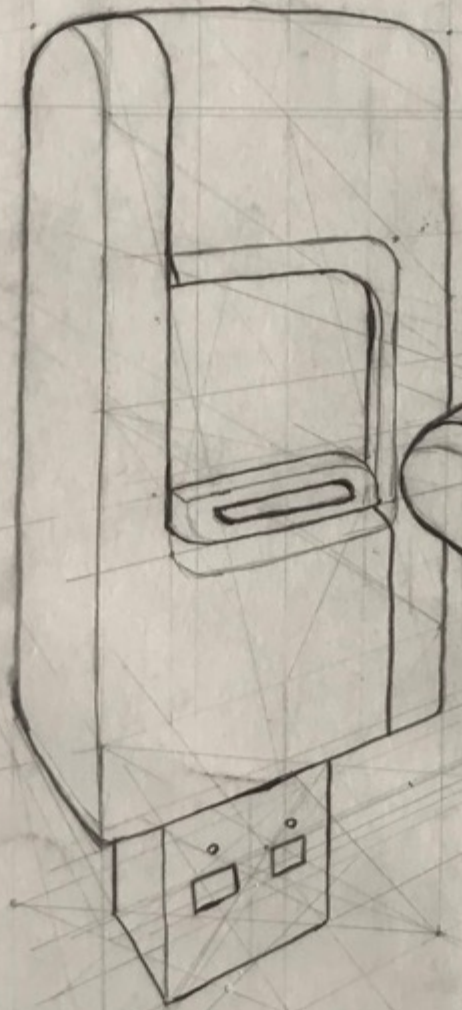
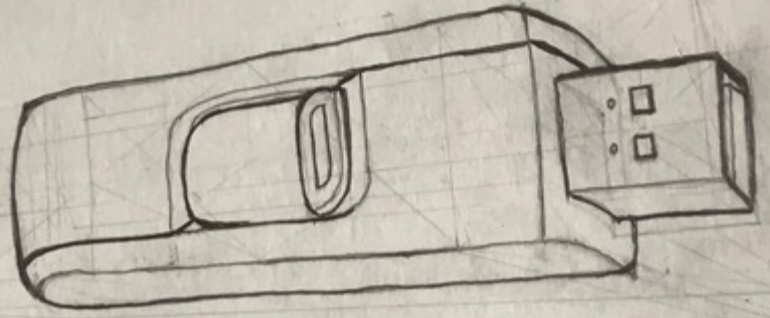

Final

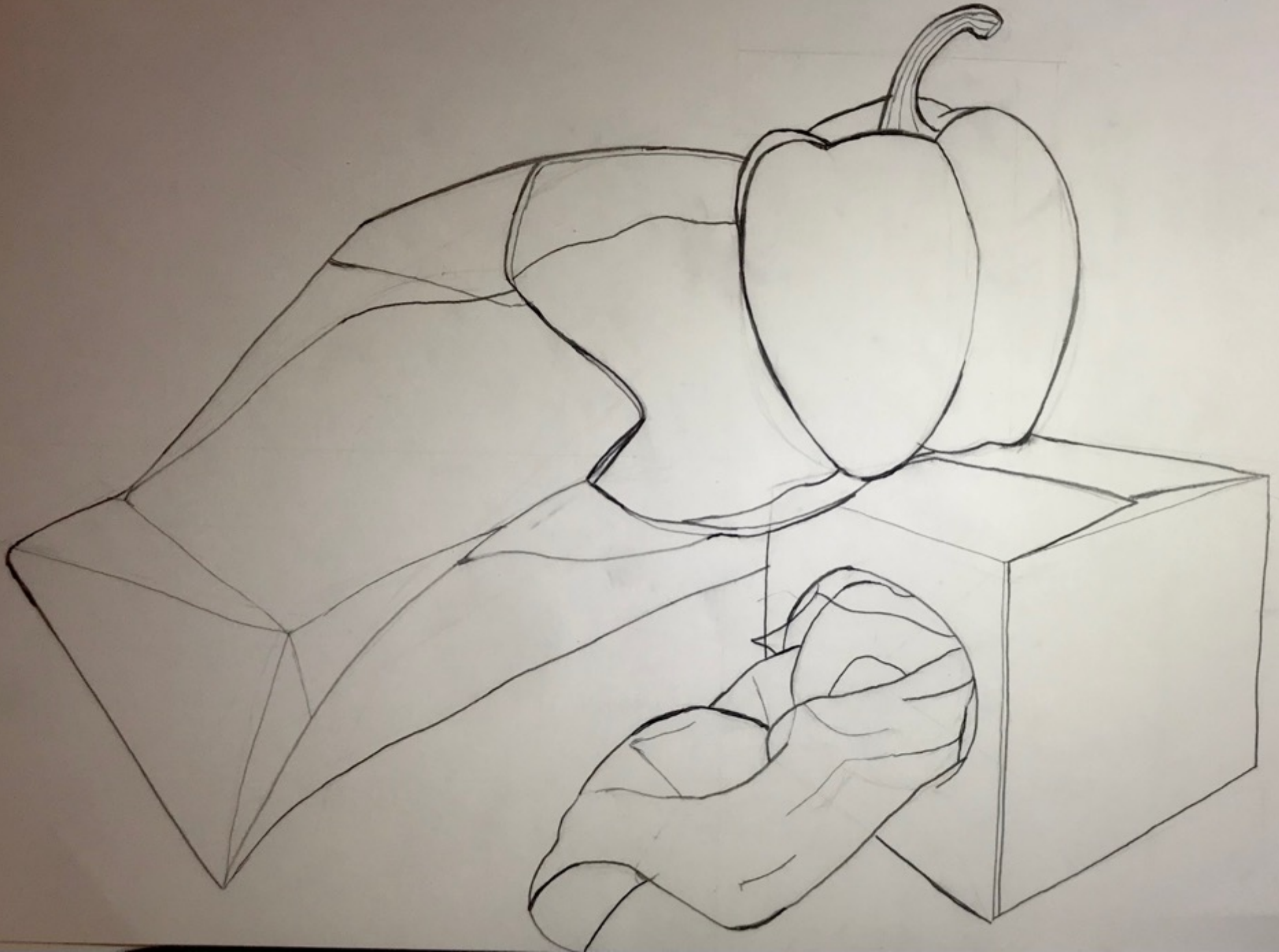

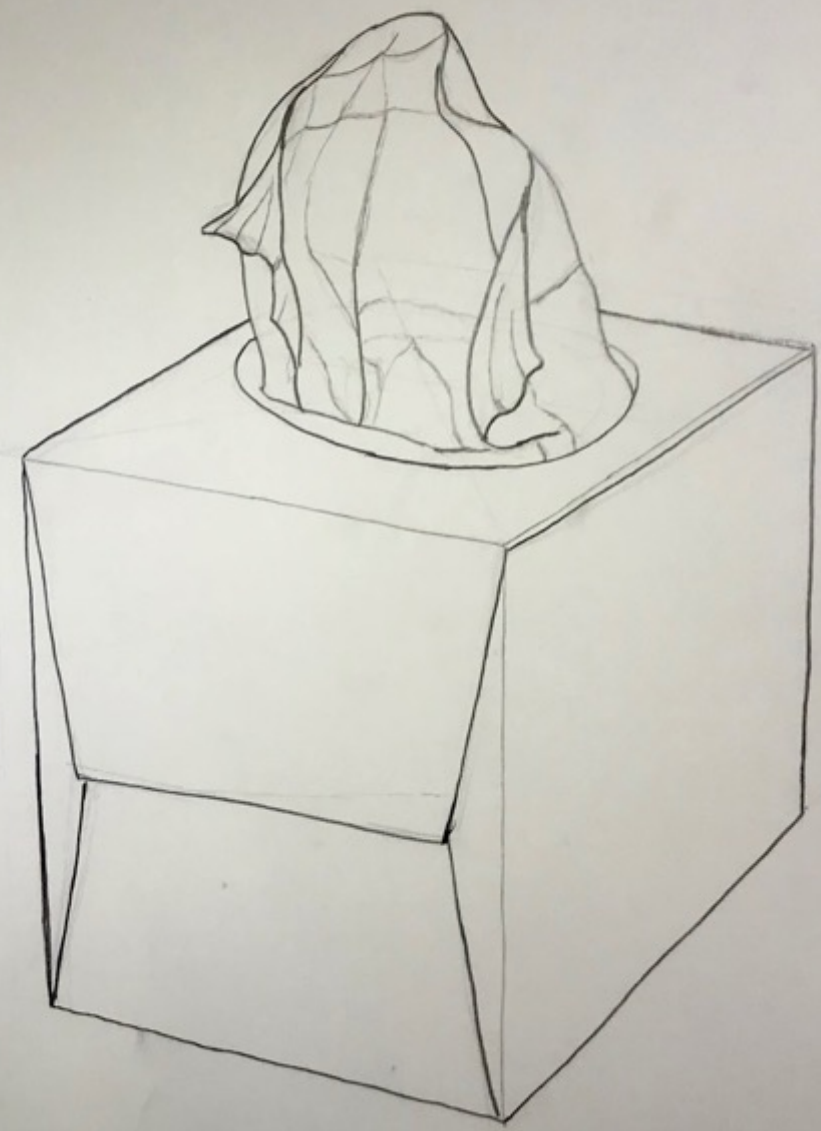
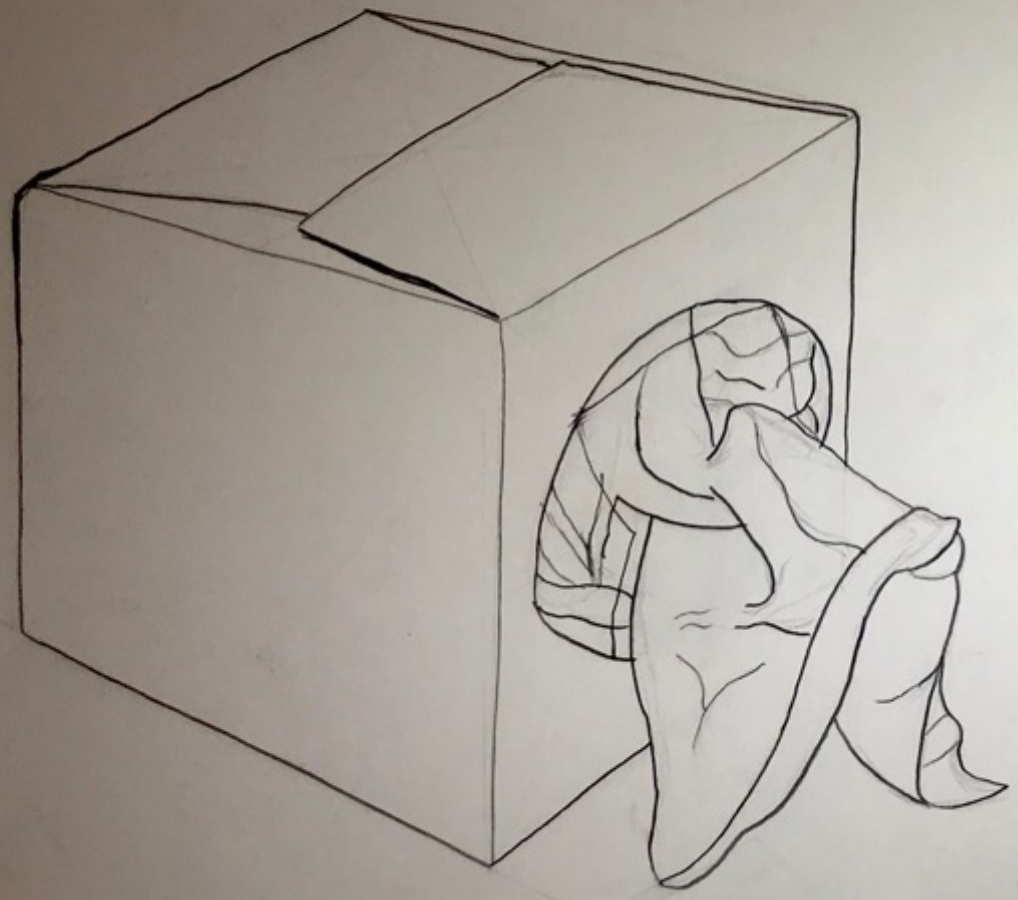

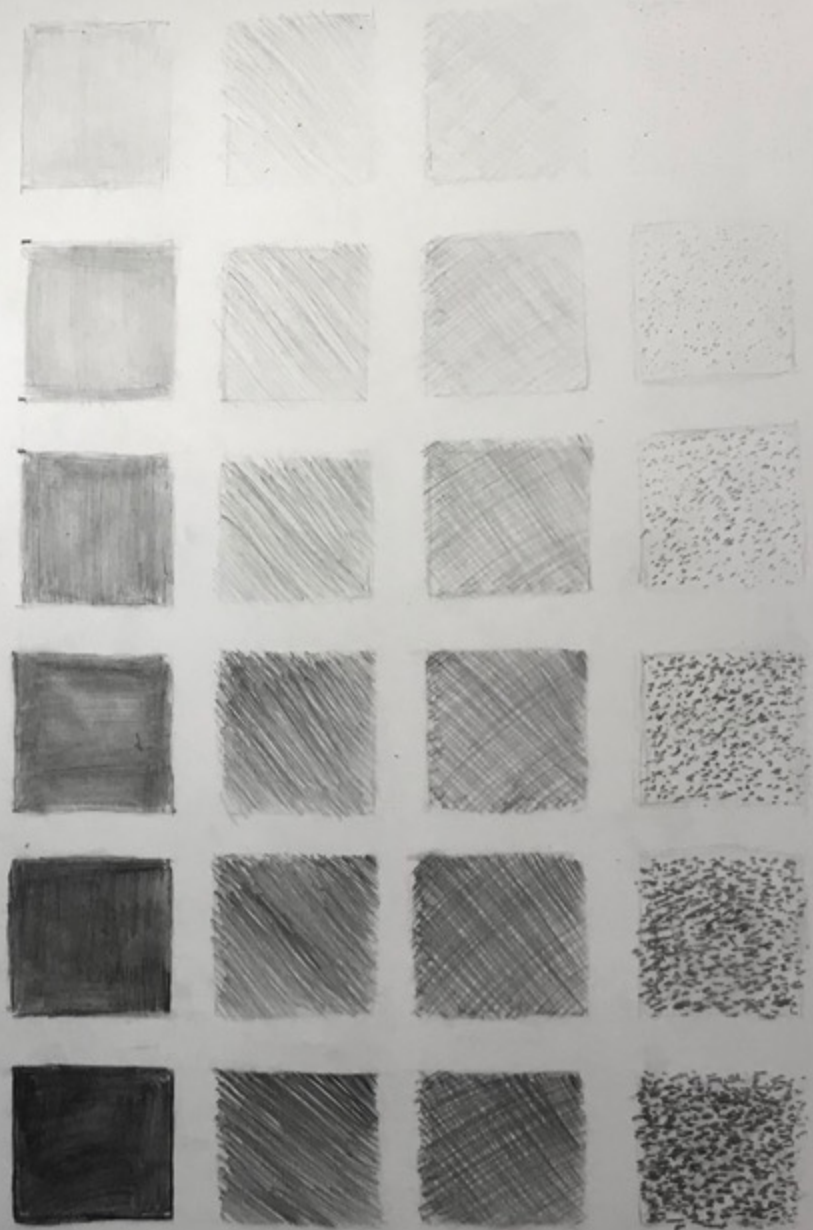

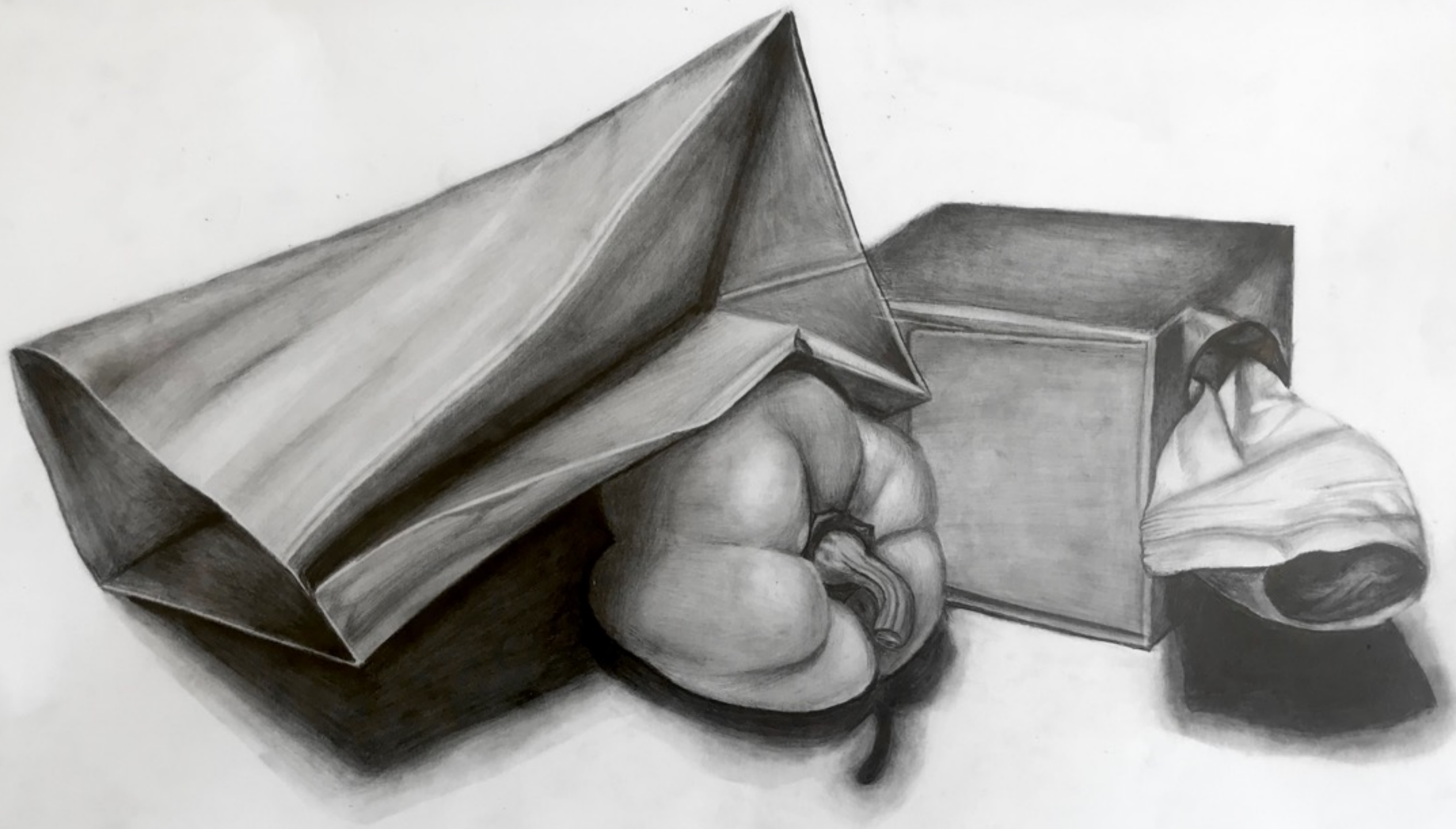

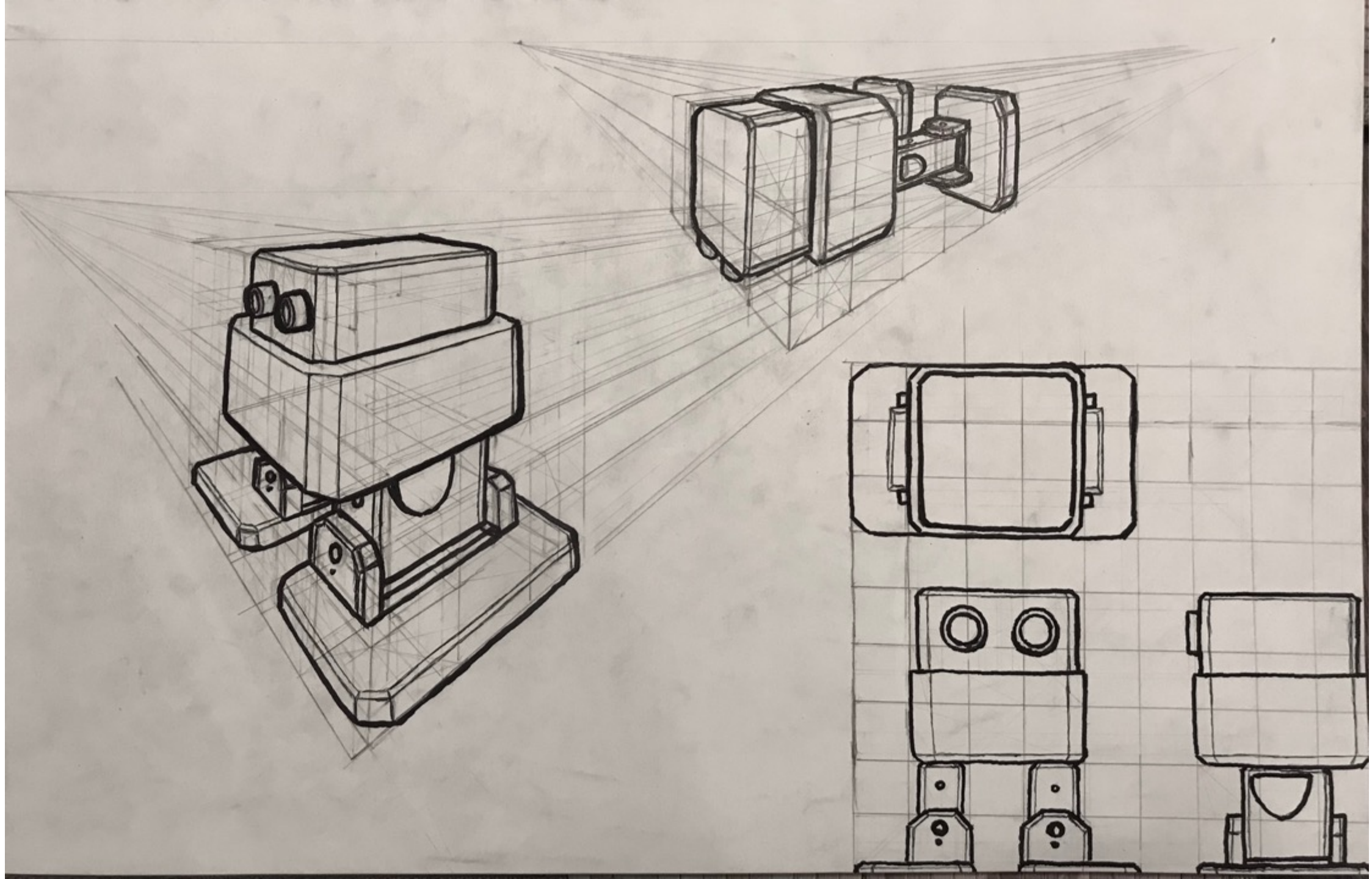

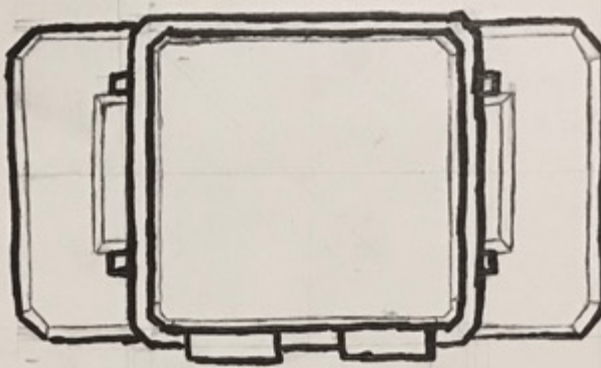
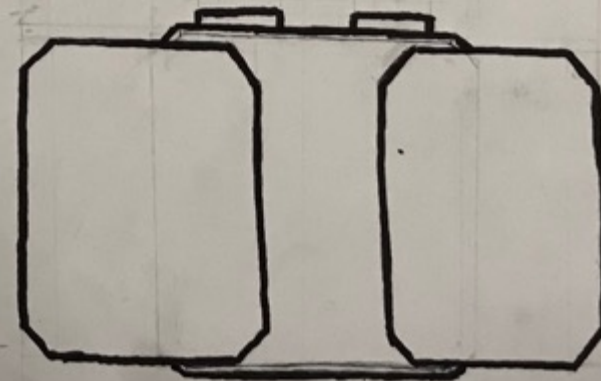
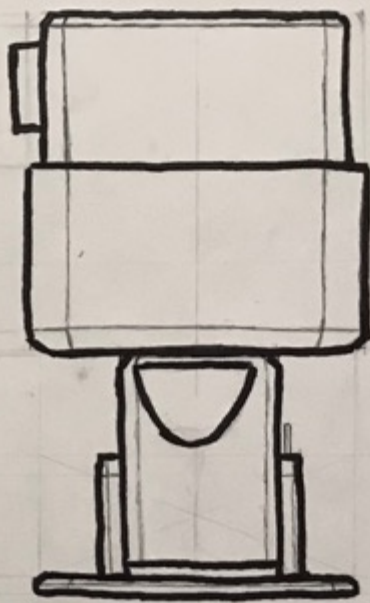
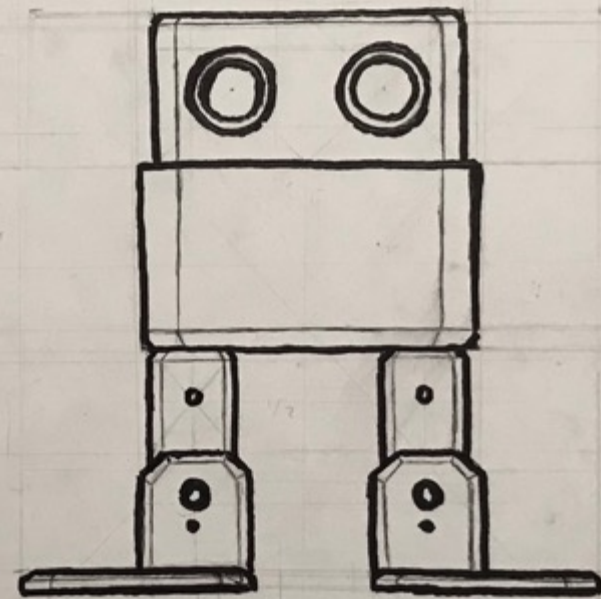
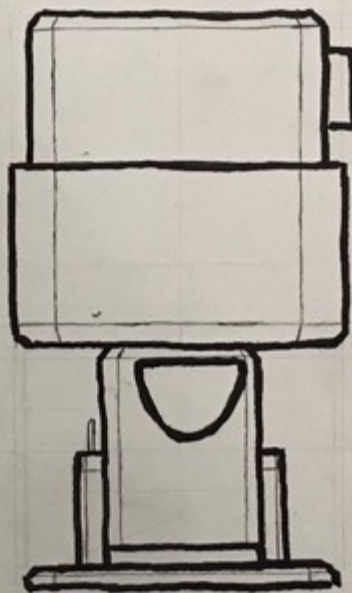
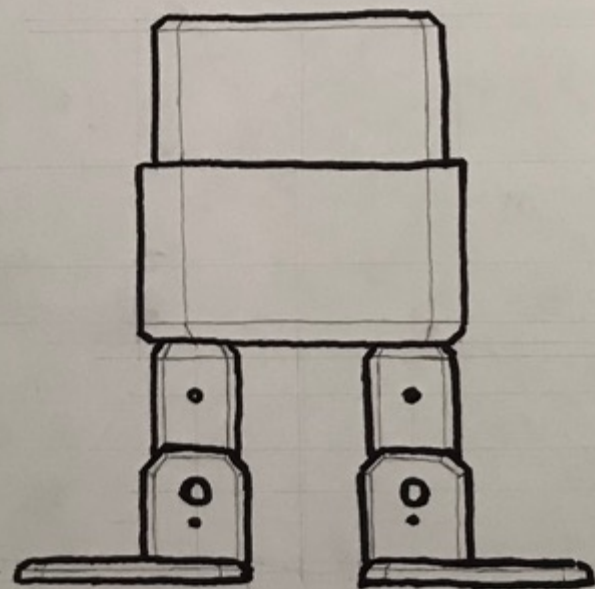

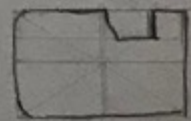
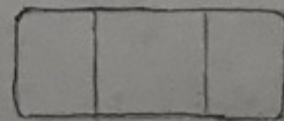
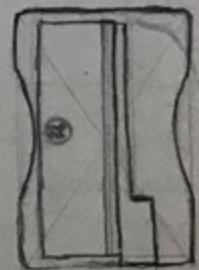
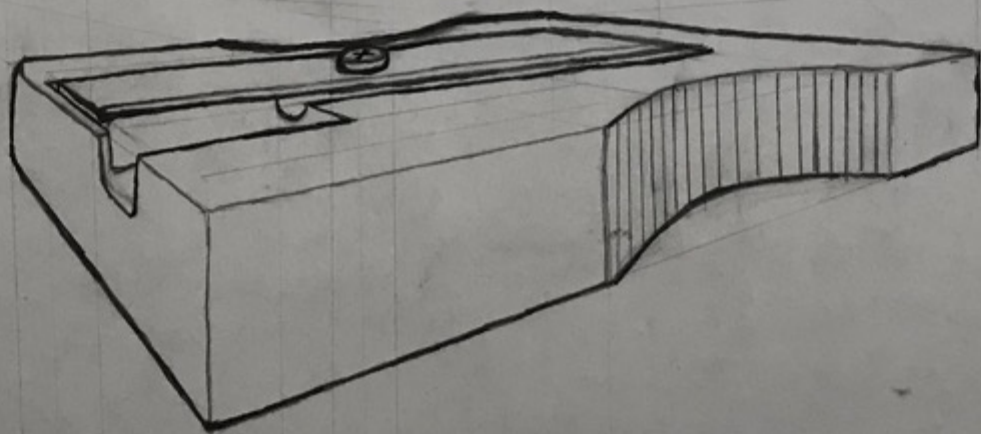
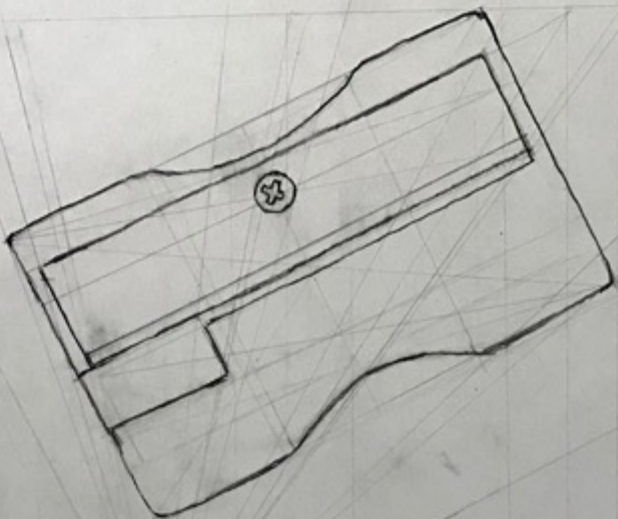

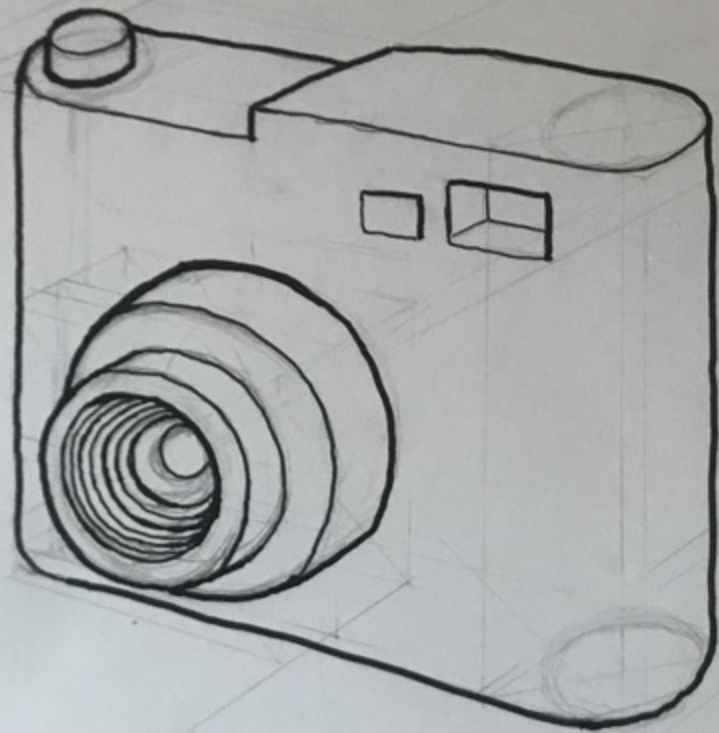

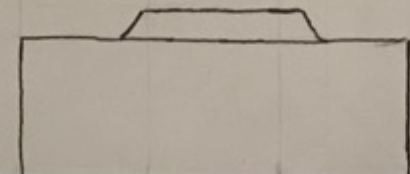
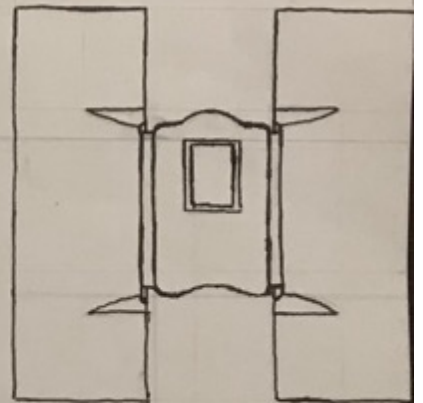
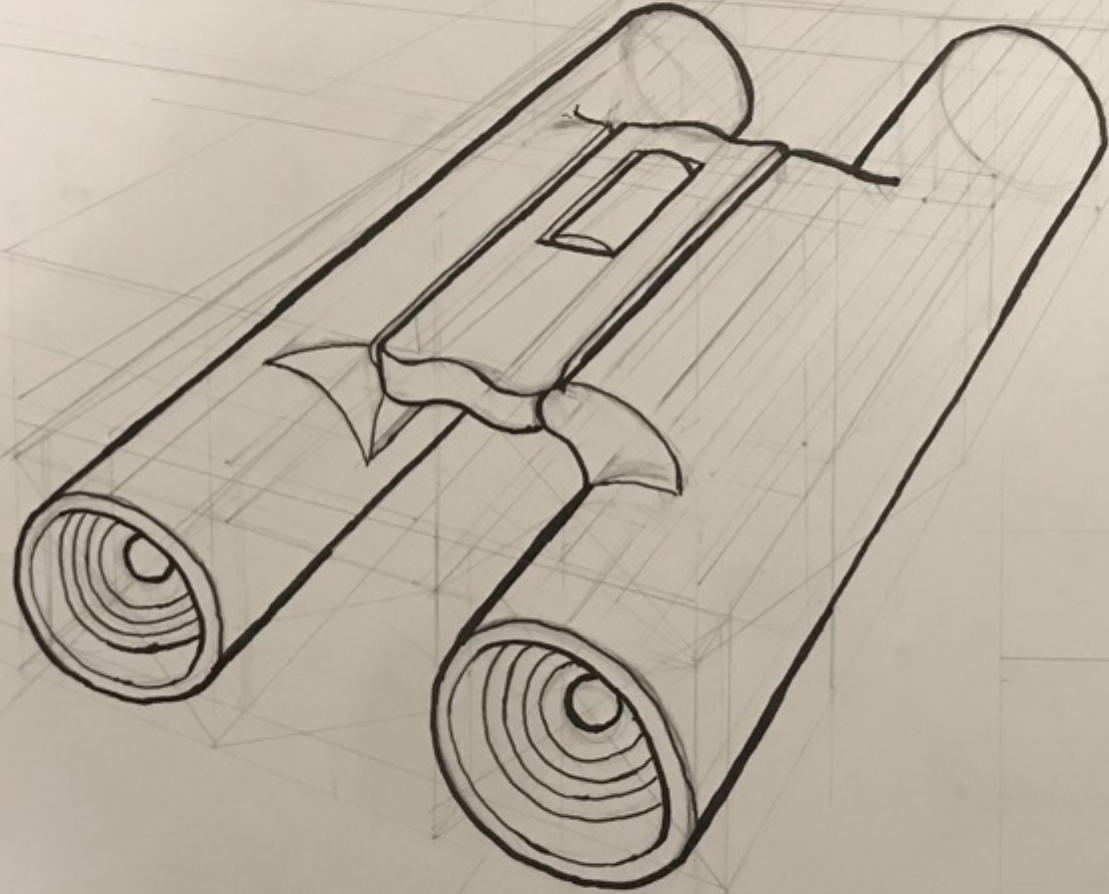

Magnifying glass

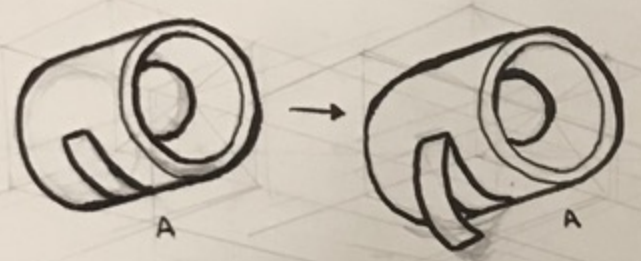

Binoculars

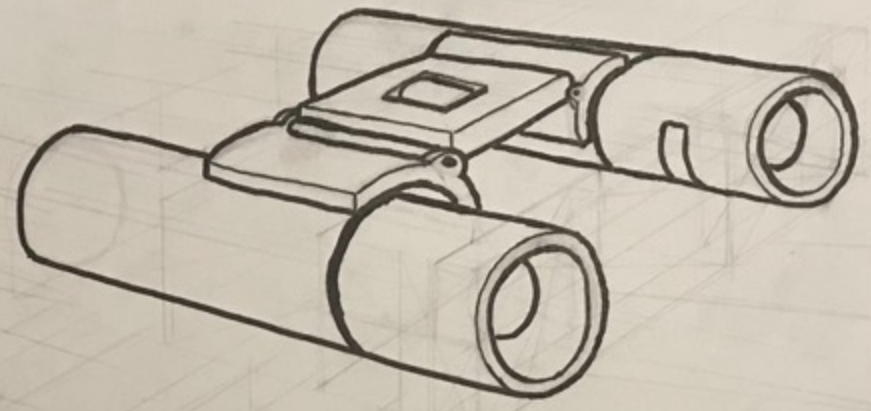

Exploded view

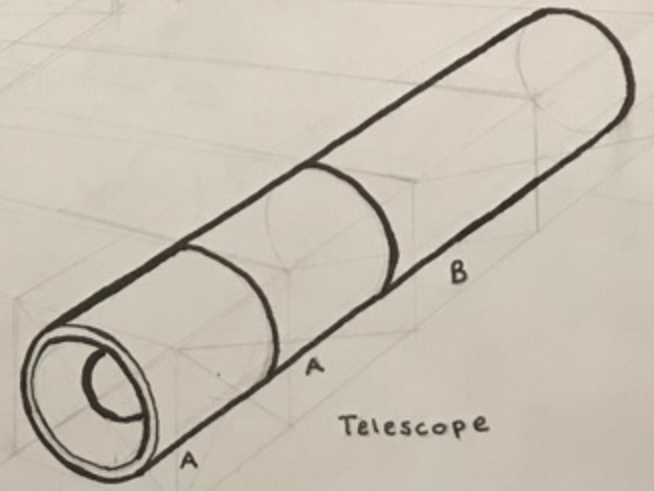
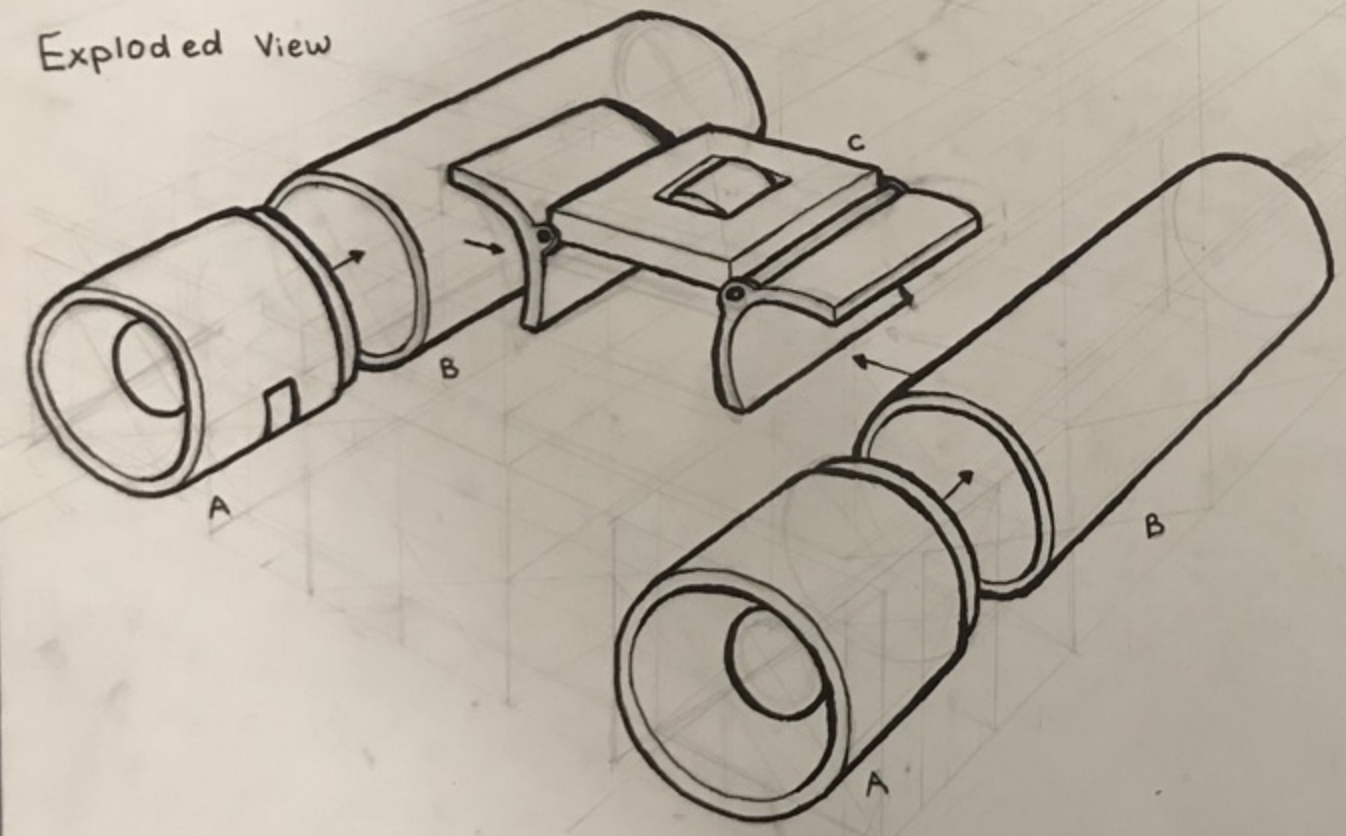

Telescope

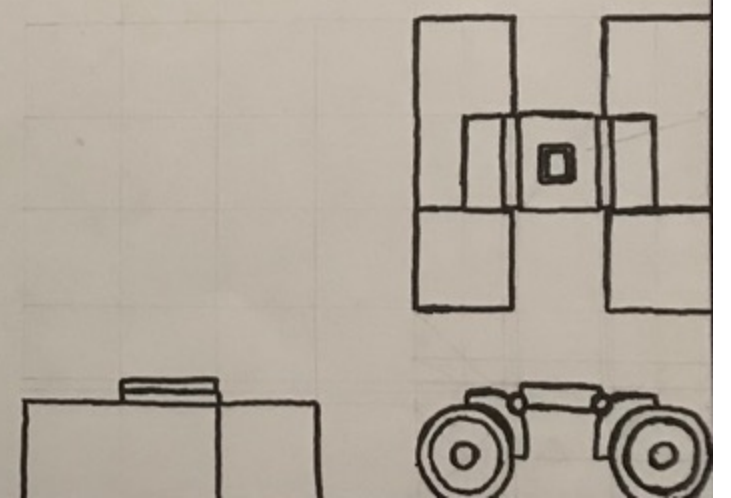

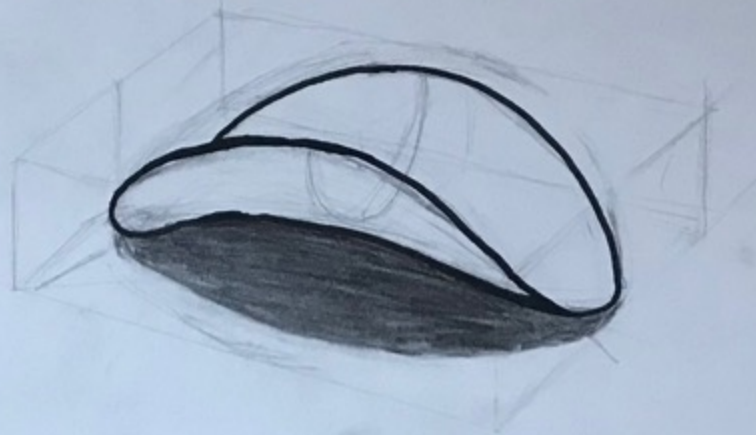
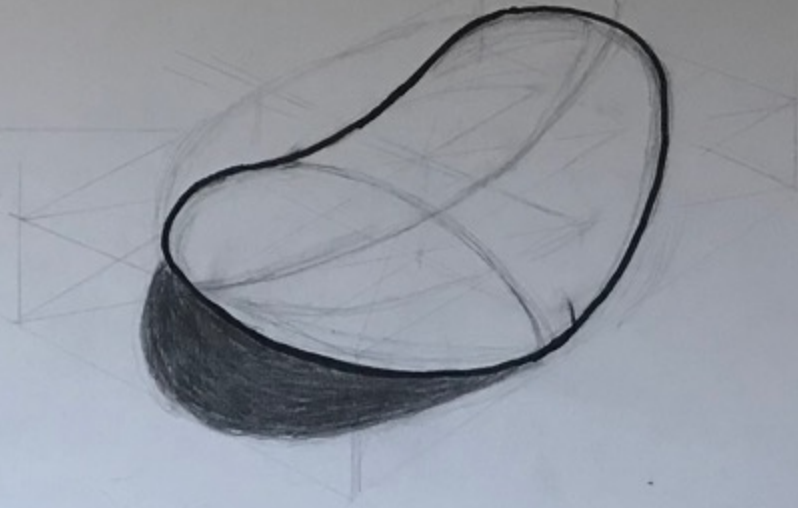
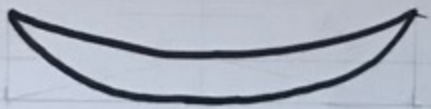
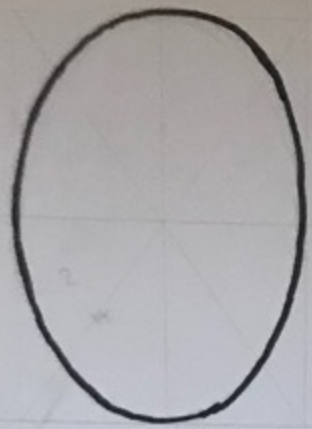

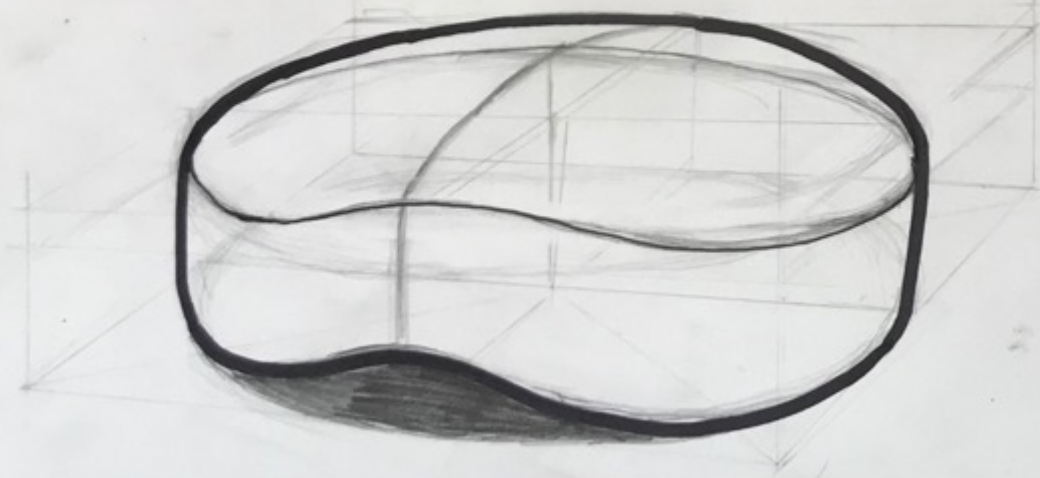
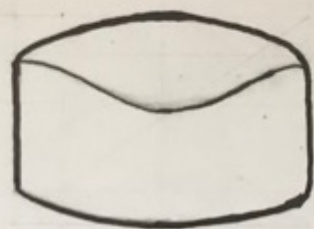
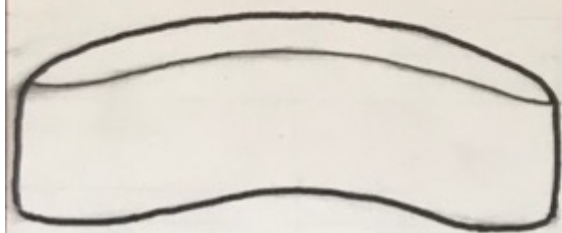

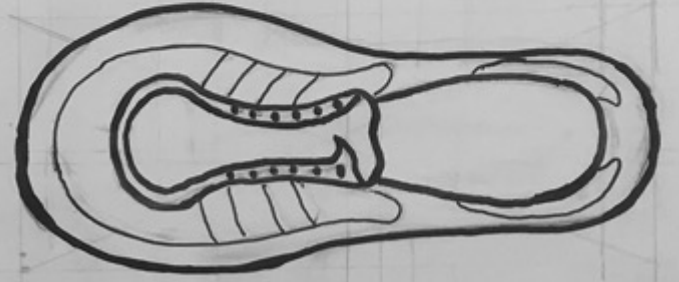
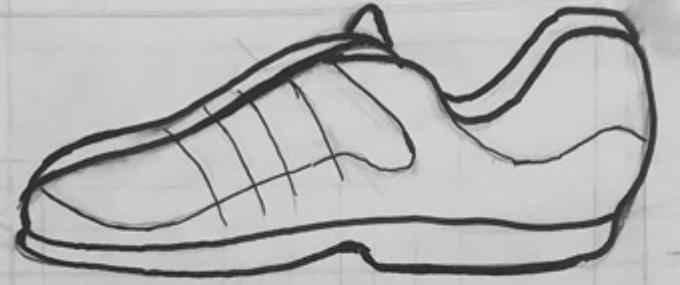

Hands-Free Self-Tying Shoe

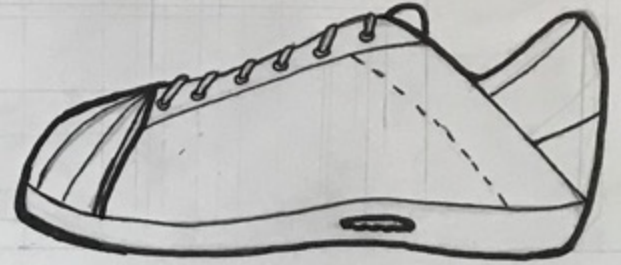
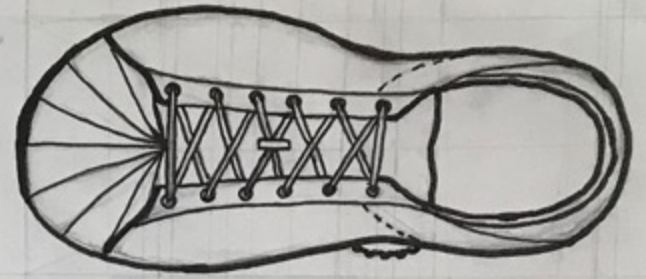

← Heel Bends down to easily slip on

Spin wheel w/ foot to tighten, push in to release