

DESIGN PORTFOLIO

SHREYASH KUDVE

DESIGN ENGINEER



Shreyash Kudve

kudvesheyash.sk@gmail.com

+919561243098

Address

103, Sonal Villa, Achole Road,
Nallasopara (East)
Palghar-401209

Skills

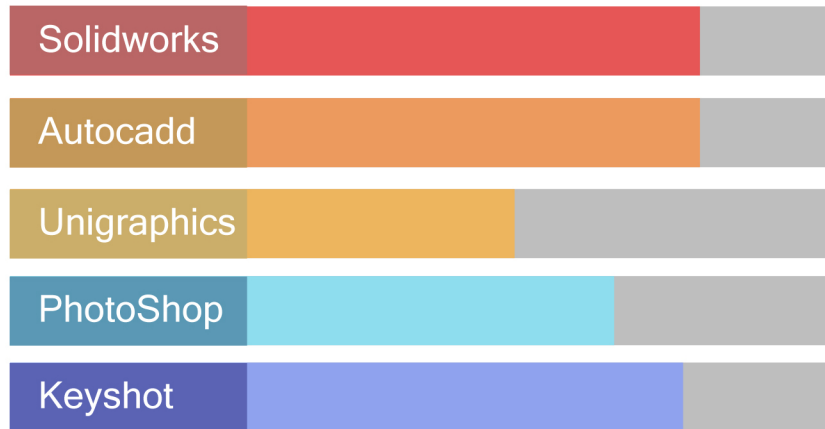

Projects @

<https://grabcad.com/shreyash.kudve-1/projects>

Education



Diploma in Mechanical Engineering
Mumbai University (March'14)



Higher Secondary Certificate
Mumbai University (March'11)



Secondary School Certificate
Mumbai University (March'09)

Experience



CADD Engineer

CADD Center (Vasai) (2014 - 2015)



Design Engineer

Vishal Lasers and Engineering (2015 - 2016)



Design Engineer

Agnee Engineering (2016-2017)



Design Engineer

Freelancer

Clientele: › Agnee Engineering

› Riddhi Heatron

› Emagination Projects Etc.

INDUSTRIAL DESIGN

FURNACES

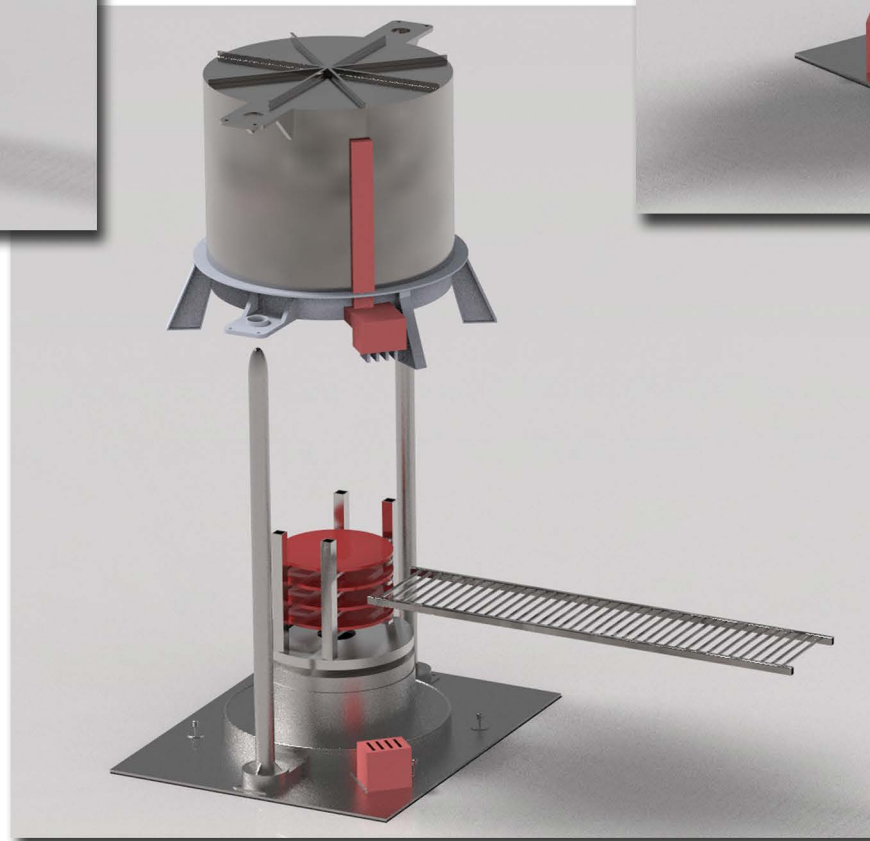
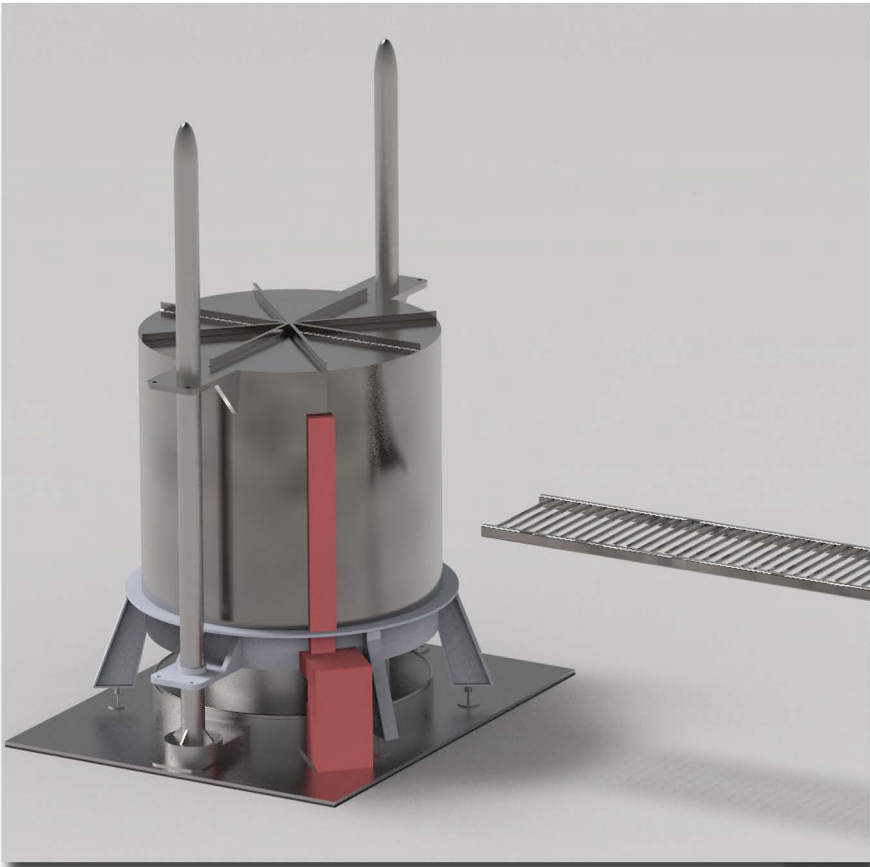

BELL TYPE FURNACE

BOGIE HEARTH FURNACE

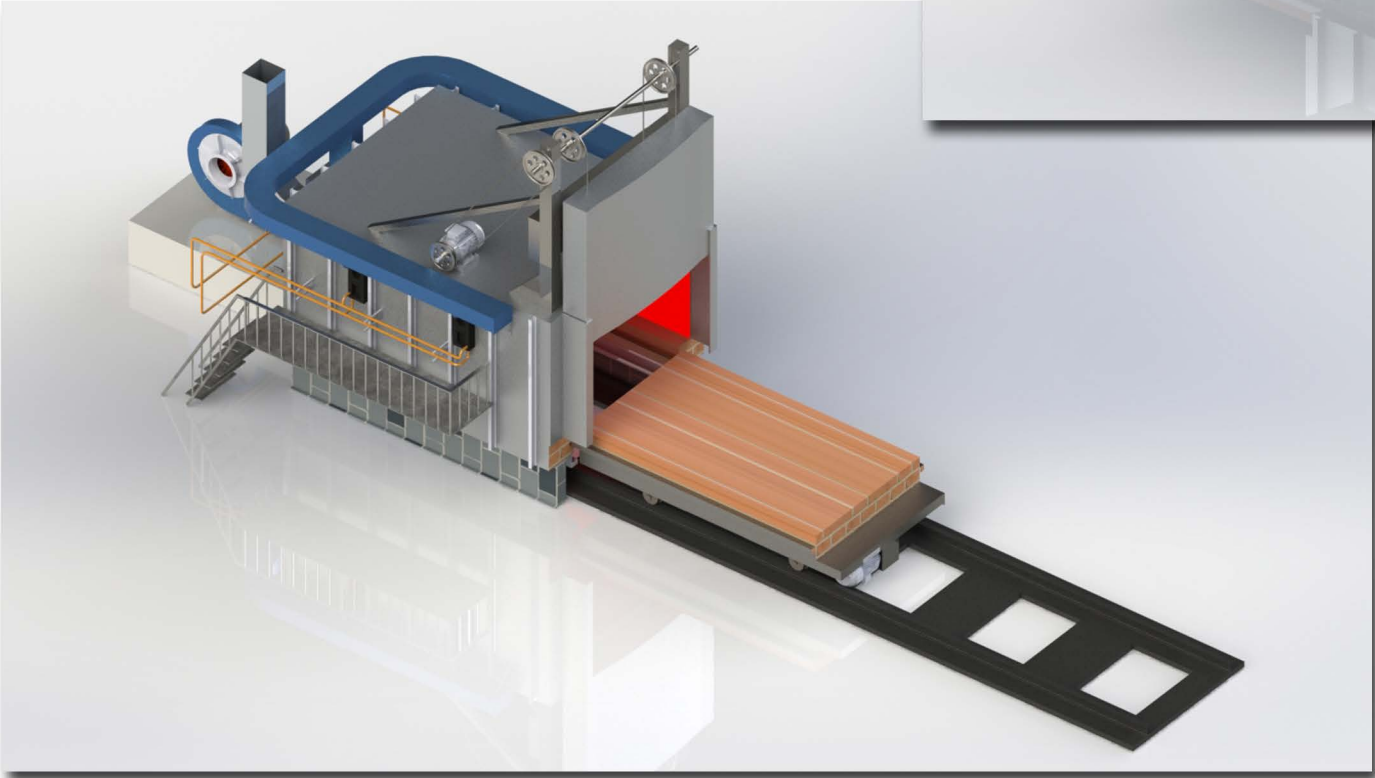
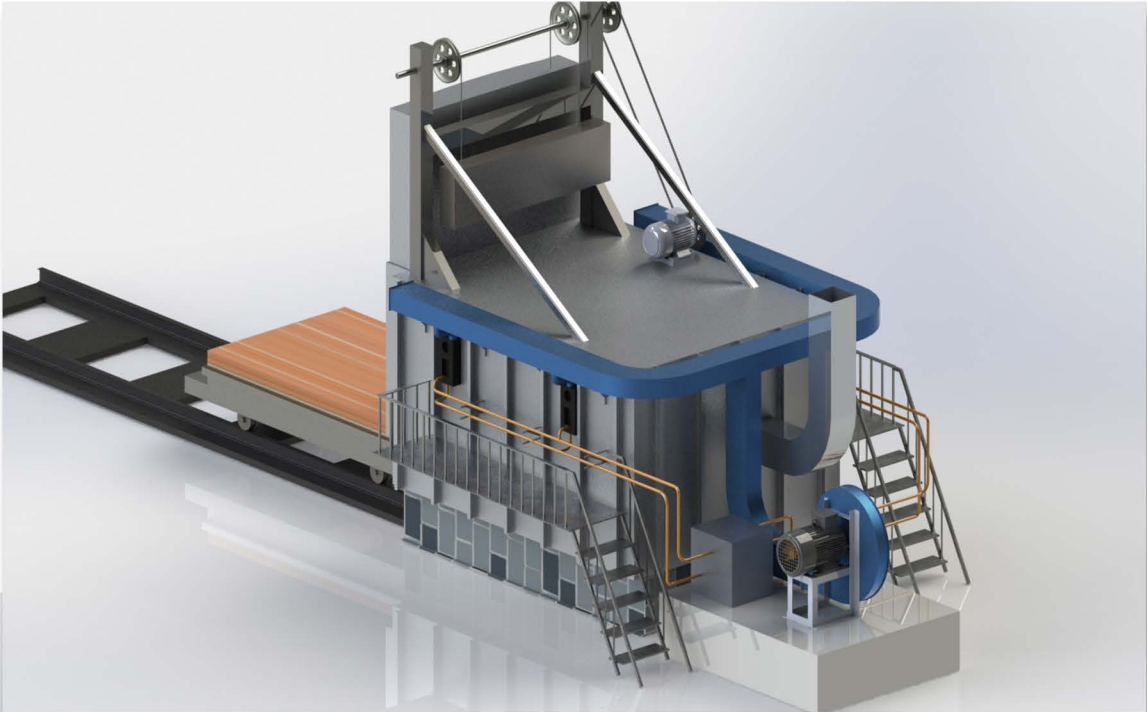

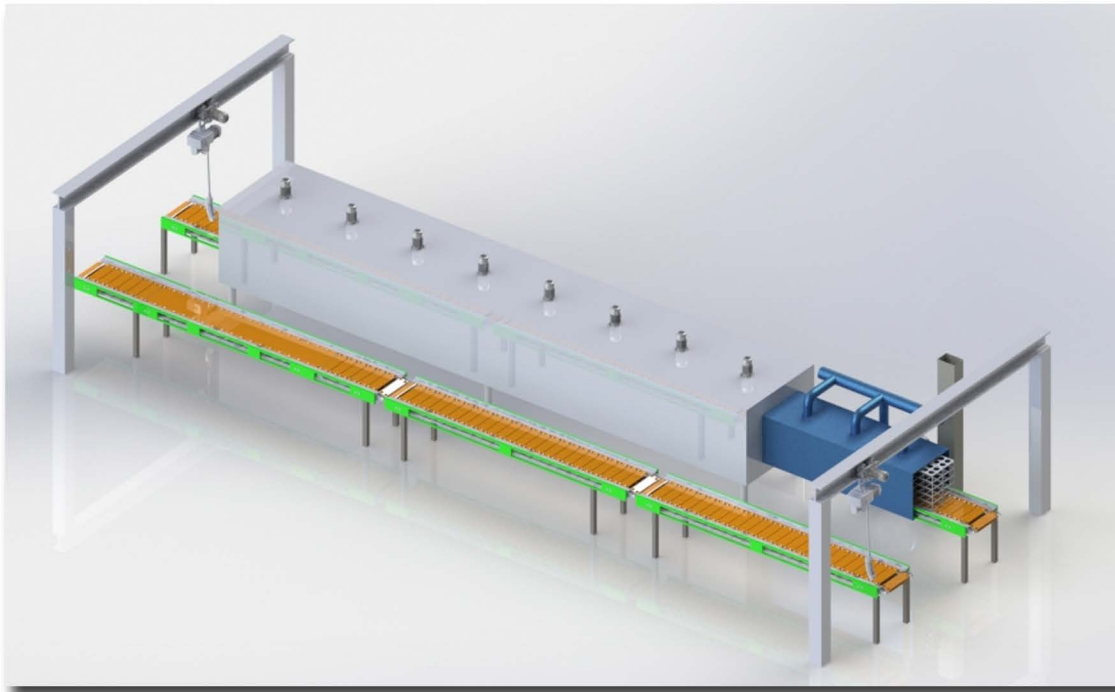

ANNEALING FURNACE

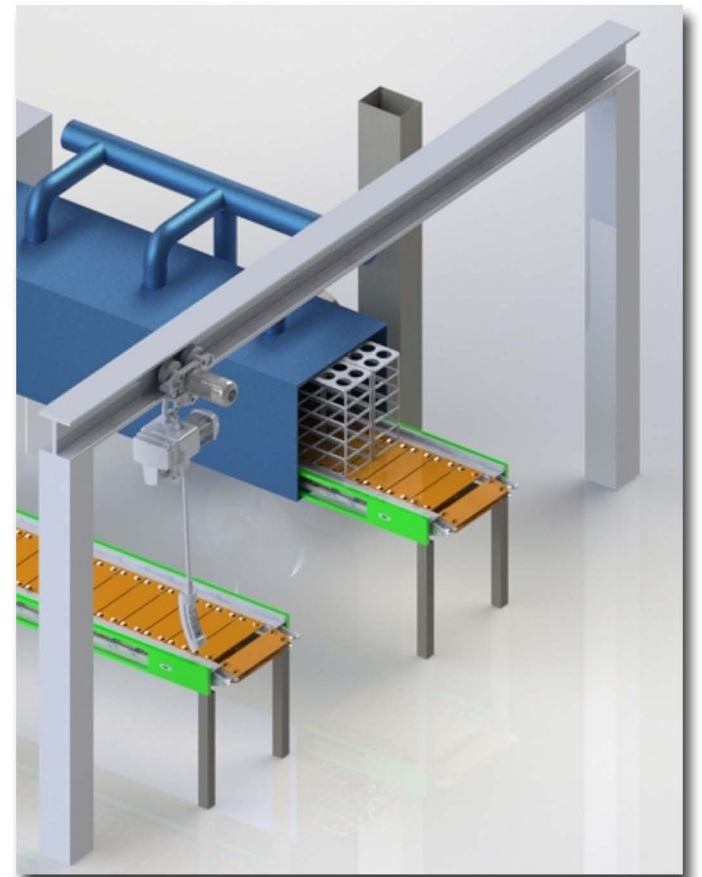
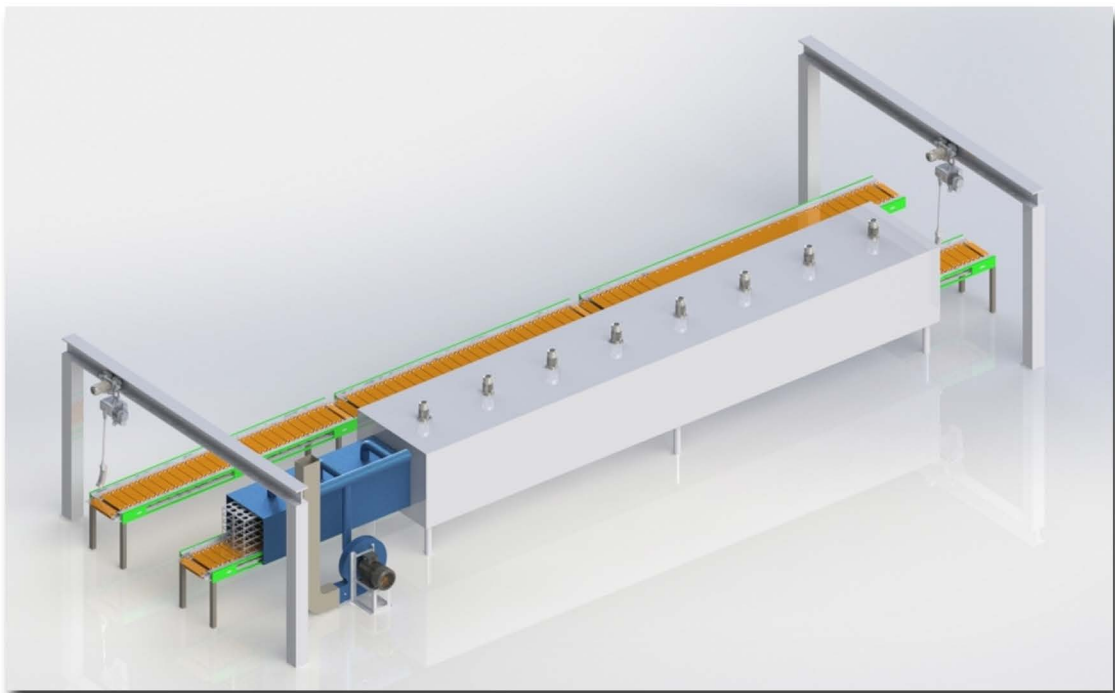

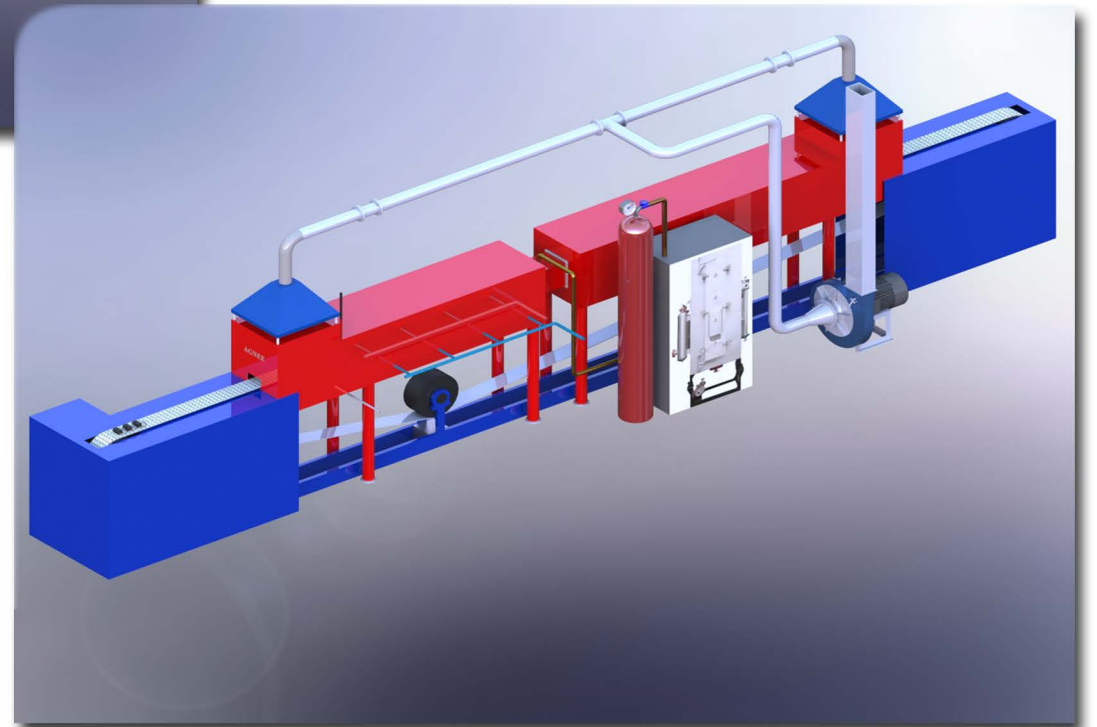
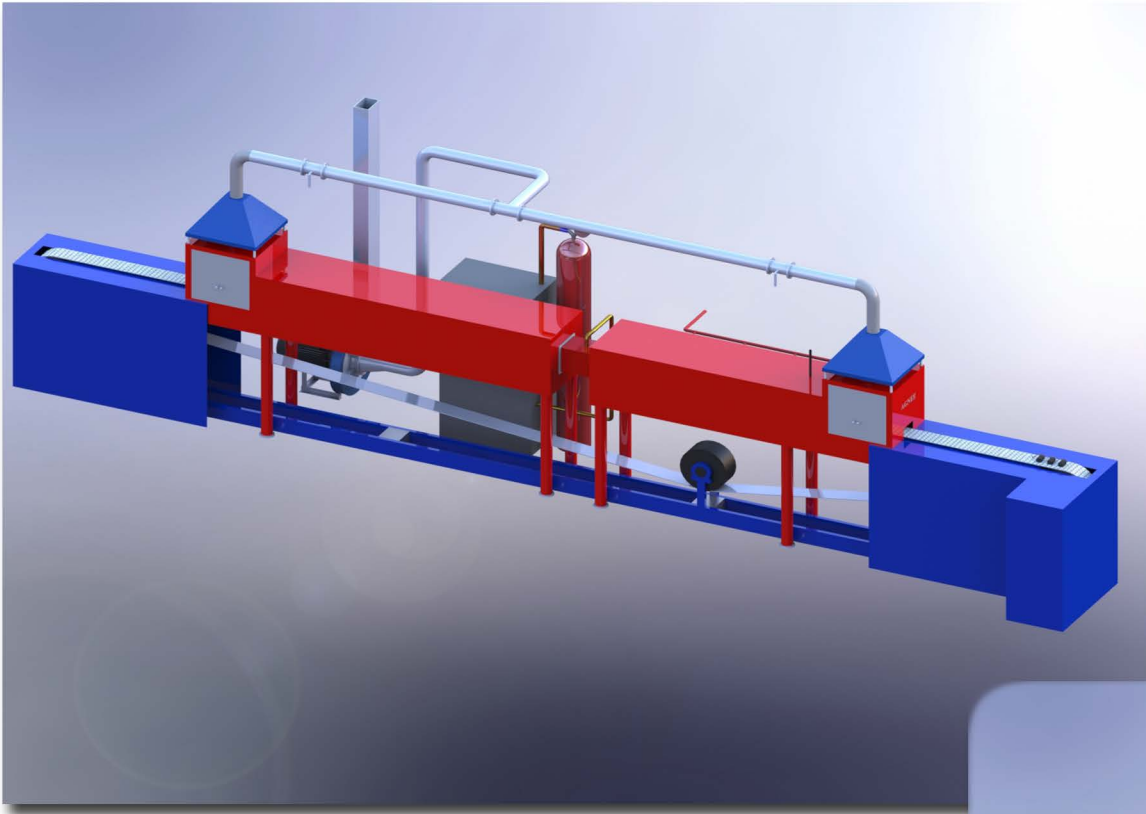

BRAZING FURNACE

SHEET METAL WORK FOR SAMSUNG



INDUSTRIAL DESIGN

RESEARCH AND DEVELOPMENT

GOLD MELTING FURNACE



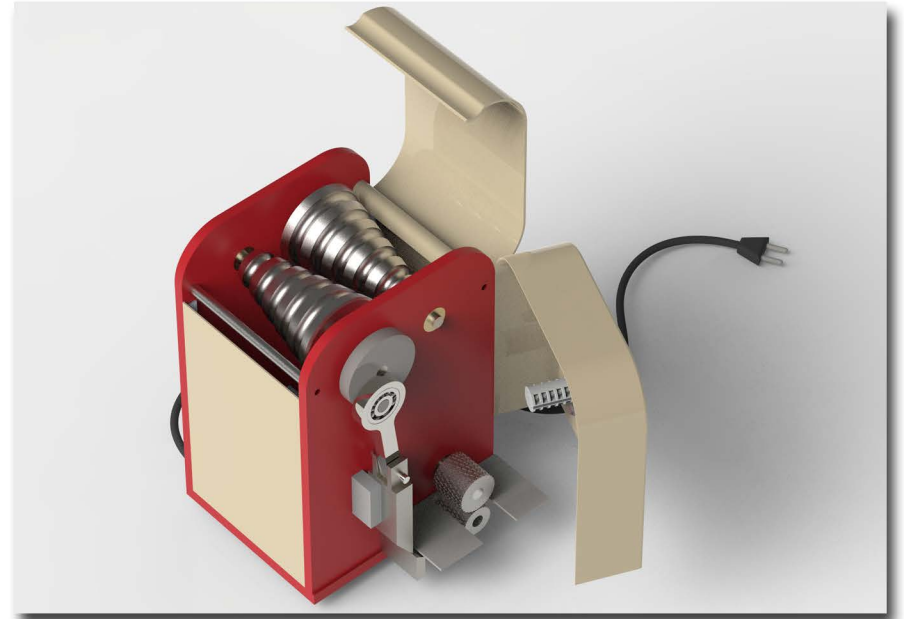

BELT LOOP CUTTING MACHINE



AUTOMOTIVE AND RENDERINGS

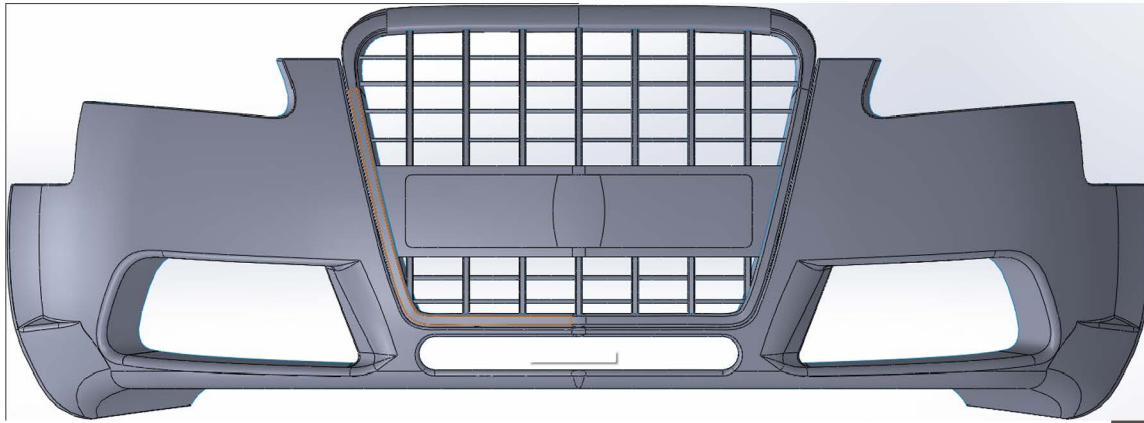

AUDI A3 FESSICA
ASSISTING IN COLLEGE PROJECT

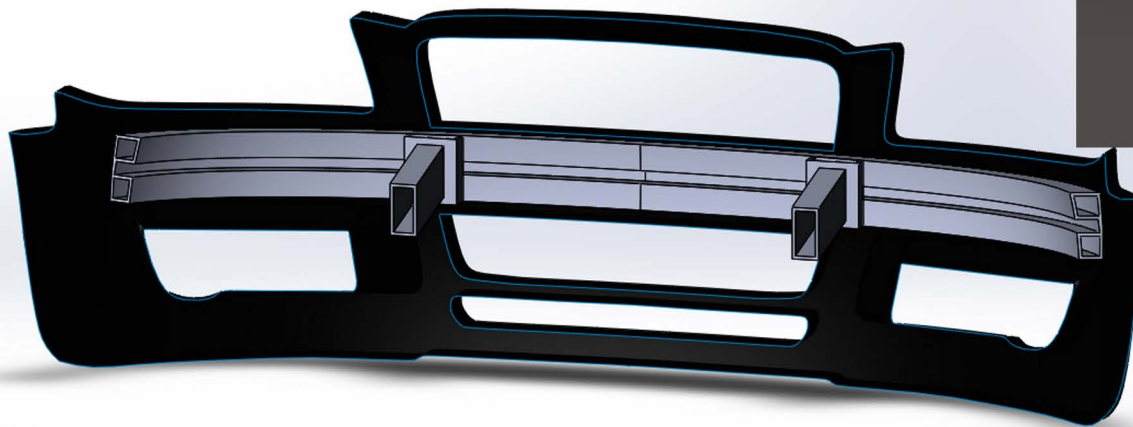
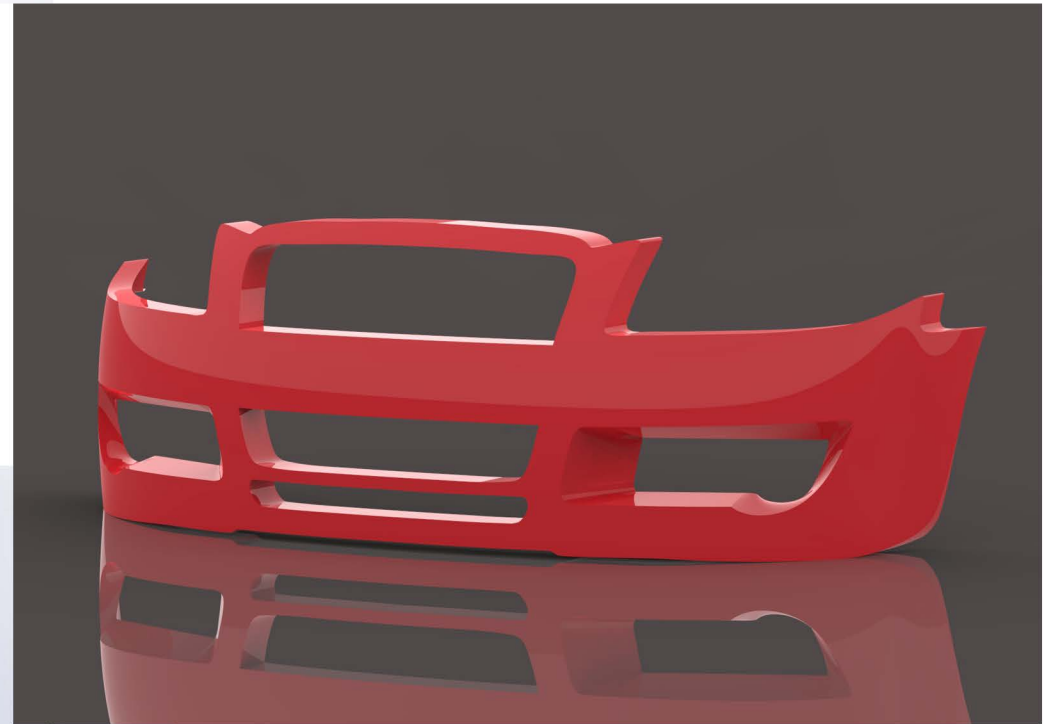

FORKLIFT



RC-HELICOPTER

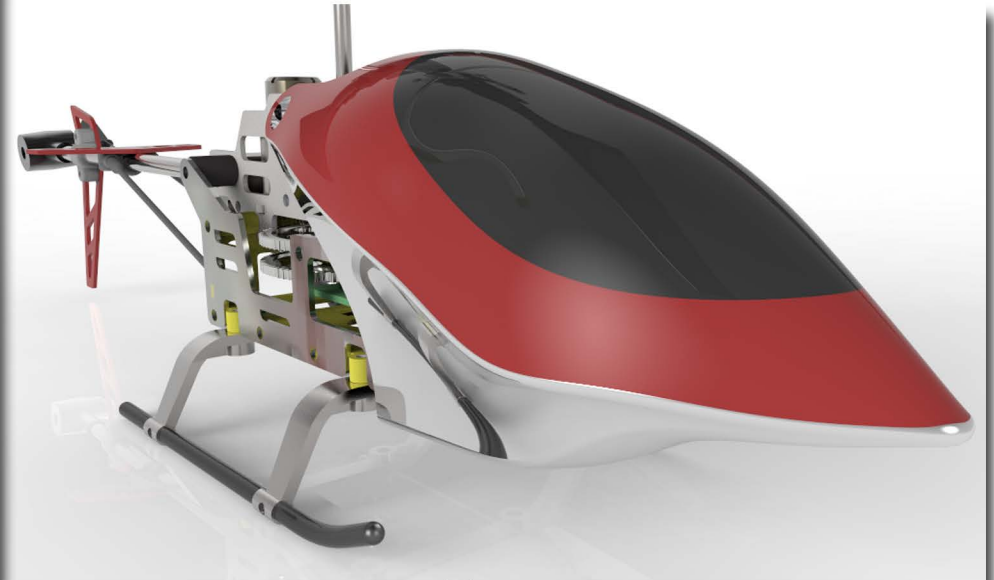

SHOCK ABSORBER

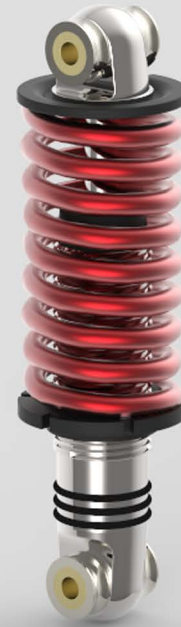

JET ENGINE FAN

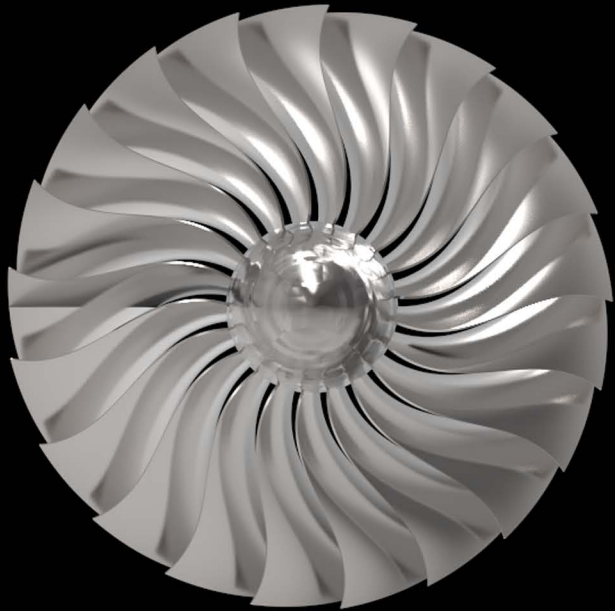

KITCHEN SINK

